



FEATURES & BENEFITS

- Lever/Pad variant: non-handed
- Dual spindle locks suitable for 92/62 PZ centres
- Designed for front door application
- 32mm width, blank backplate option available
- Die-cast Aluminium or Zinc Alloy
- 2 year surface finish guarantee thanks to durable PVD coating
- Porcel Coat offering a durable surface finish, exceeding 3,000 hours neutral salt spray when tested in accordance to BS EN 1670:2007
- Colour co-ordinated screw heads
- Packaged 1 pair per box, 20 boxes per carton



DOOR HANDLE

313

The Claymore Lever/Pad door handle compliments the Claymore series of window handles, hinges and Zinc-framed letterplates.

Designed for applications where a long backplate is required, the fixings are sited above and below the handle grip.

Each handle set supplied with two twin internal spring cassettes, to ensure a positive and precise operation.

CLAYMORE

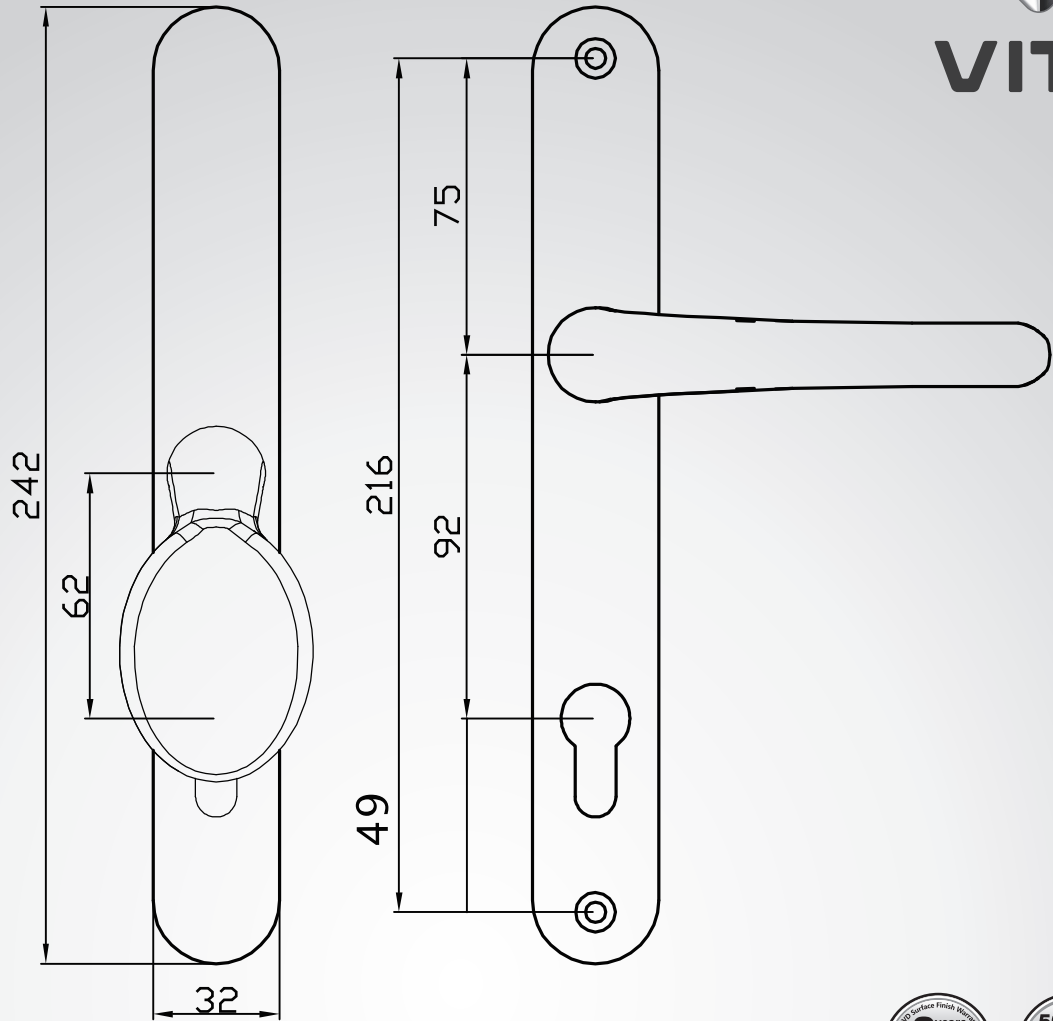











* Available with 92/92 direct drive



Colour	Coating Type	BS EN 1670 : 2007
White	Powder Coat	Grade 5 (480 hours)
Black	Powder Coat	Grade 5 (480 hours)
Polished Gold	Physical Vapour Deposition	Grade 5 (480 hours)
Polished Chrome	Physical Vapour Deposition	Grade 5 (480 hours)
Polished Chrome	Electro-Plating	Grade 4 (240 hours)
Smoked Chrome	Physical Vapour Deposition	Grade 5 (480 hours)
Satin Silver	Physical Vapour Deposition	Grade 4 (240 hours)
Lava Brown	Porcel Coat	Tested to 3,000 hours
Black Onyx	Porcel Coat	Tested to 3,000 hours
Moët Gold	Porcel Coat	Tested to 3,000 hours

AVAILABLE COLOURS

-  White
-  Black
-  Polished Gold PVD
-  Polished Chrome PVD
-  Polished Chrome
-  Smoked Chrome PVD
-  Satin Silver PVD
-  Lava Brown
-  Black Onyx
-  Moët Gold

Spindle Pack	Content	Usage
Pack E	2 * spindle 95mm	for 65-70mm door thickness